



SHAPE  
studio



Epta S.p.A. participates in the ECC programme for Refrigerated display cabinets (RDC). Check ongoing validity of certificate online: [www.eurovent-certification.com](http://www.eurovent-certification.com) or using: [www.certiflash.com](http://www.certiflash.com)



Shape SV		
Lunghezza mm	1300	1500
Shape SV	1250	•
	1875	•
	2500	•
	3750	•

1300 LS-P DESIGN

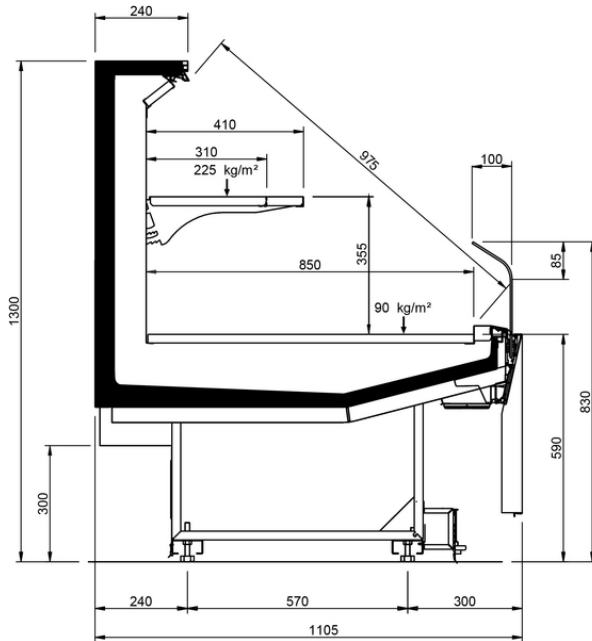

1300 LS-D DESIGN

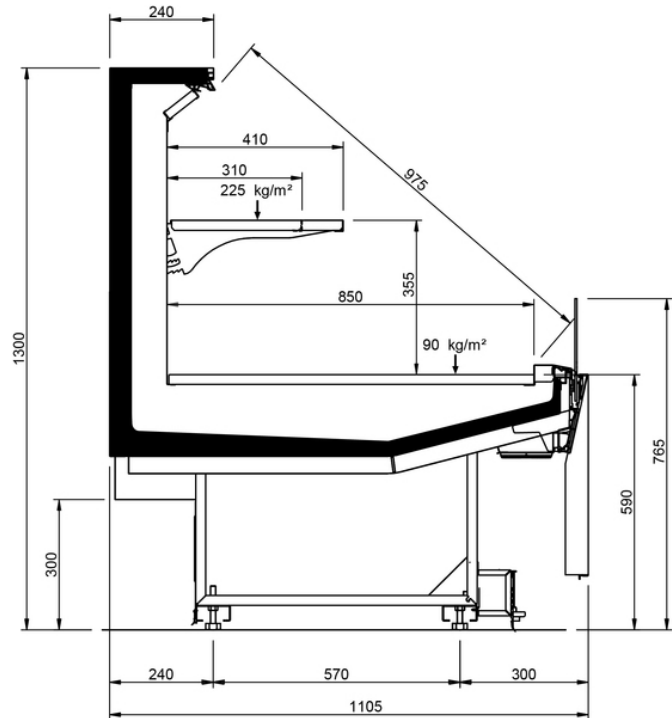

1500 LS-P W450 DESIGN

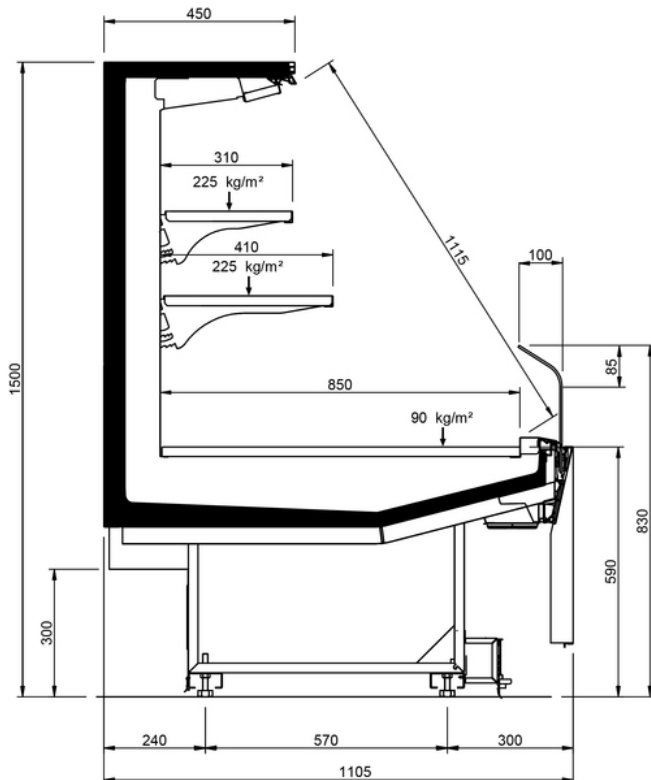

1500 LS-P W240 DESIGN

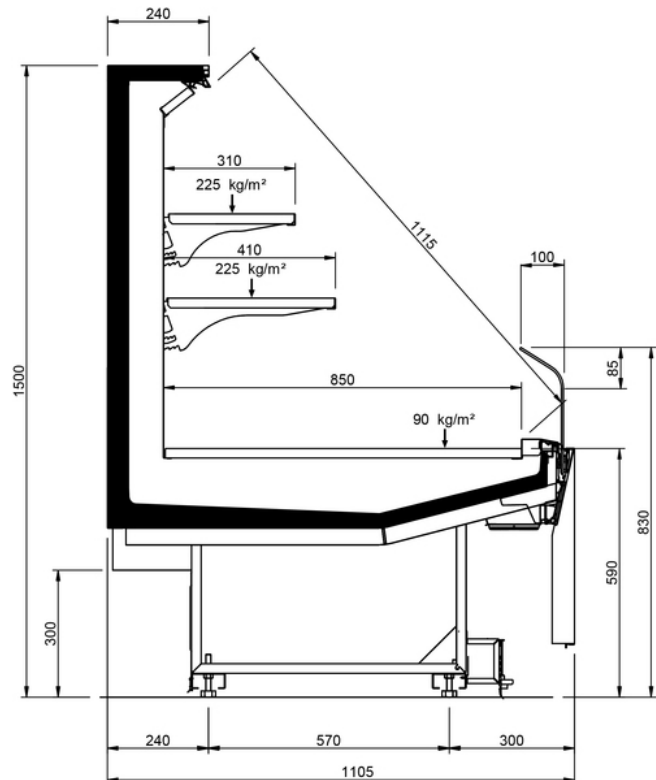

1500 LS-D W240 DESIGN

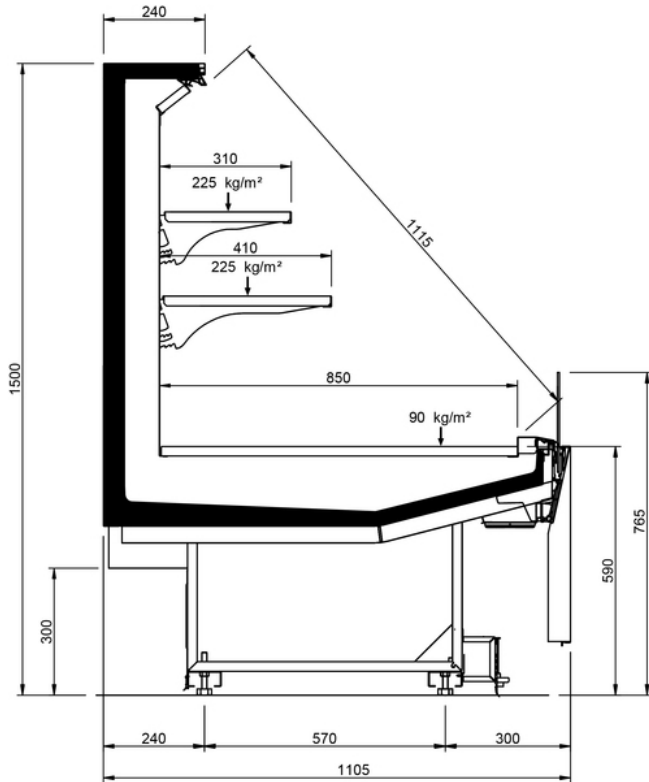

1300 LS-P STUDIO

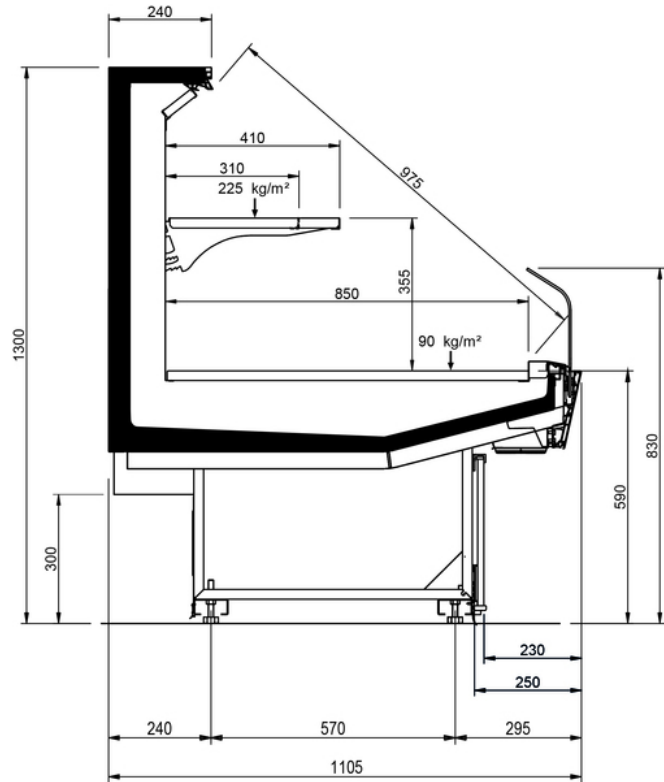

1300 LS-D STUDIO

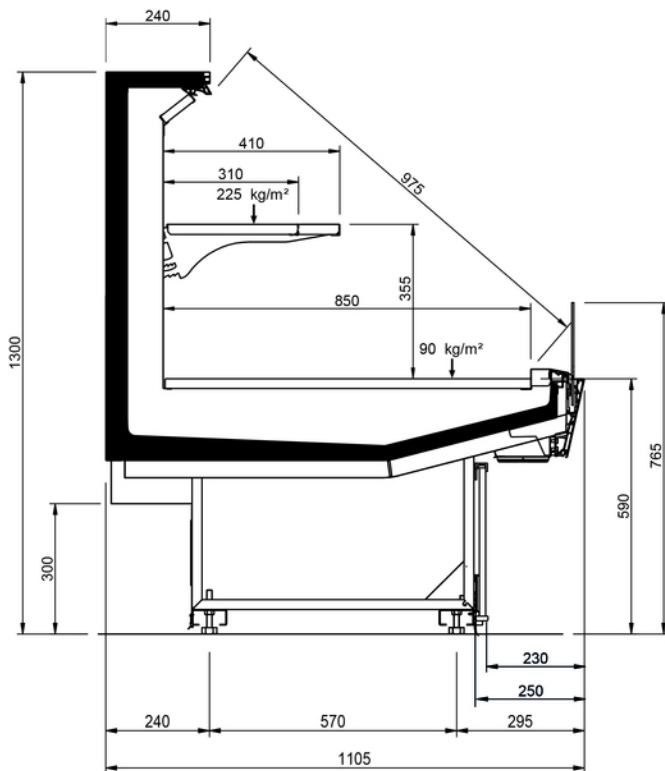

1500 LS-P W450 STUDIO

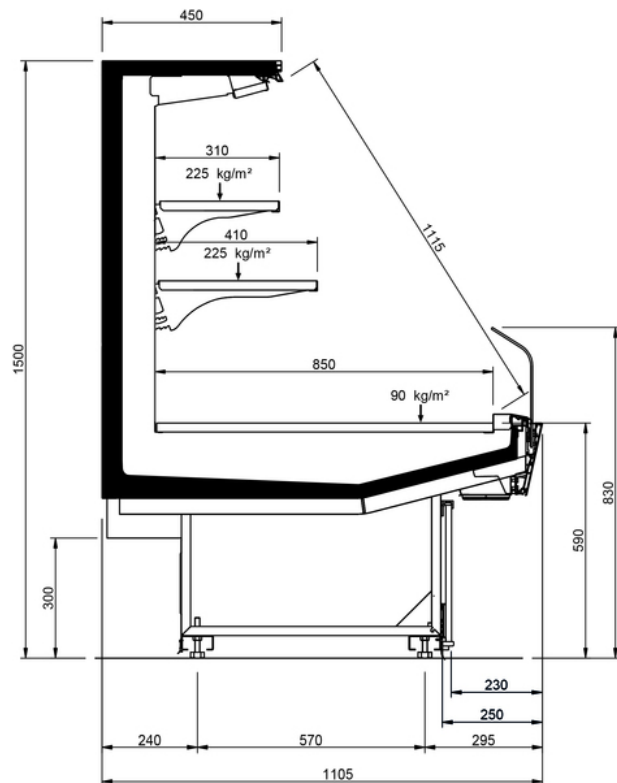

1500 LS-D W450 STUDIO

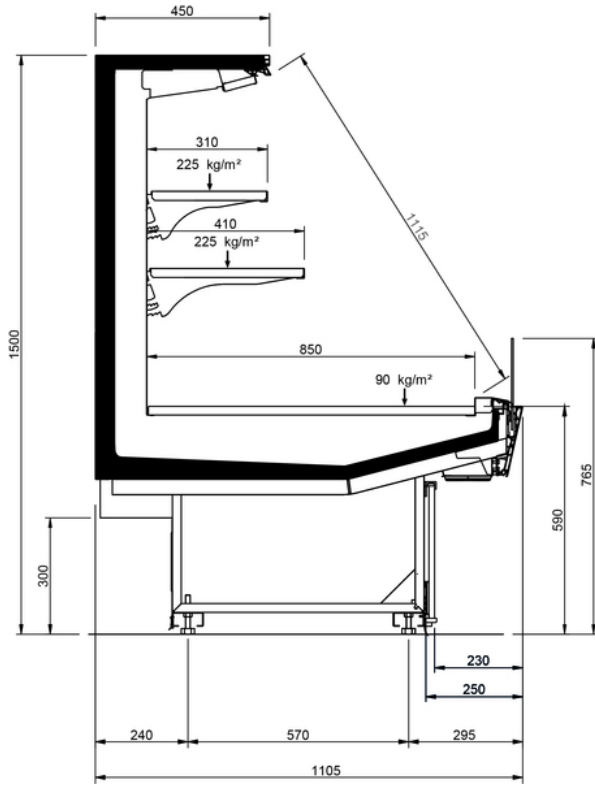

1500 LS-P W240 STUDIO

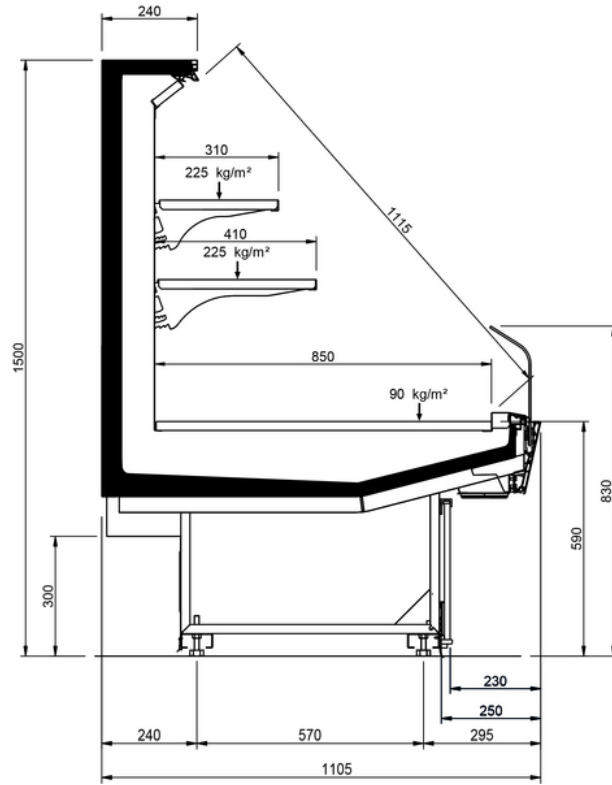

1500 LS-D W240 STUDIO

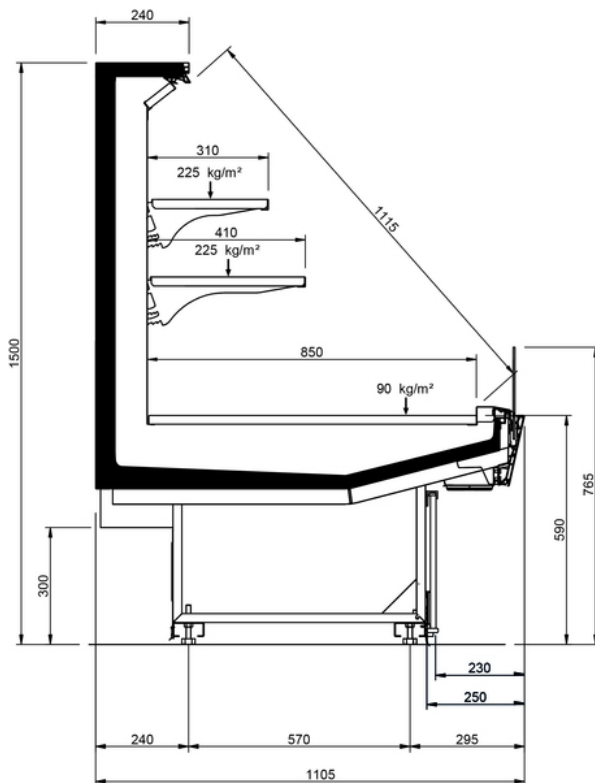

1300 LS-P STYLE

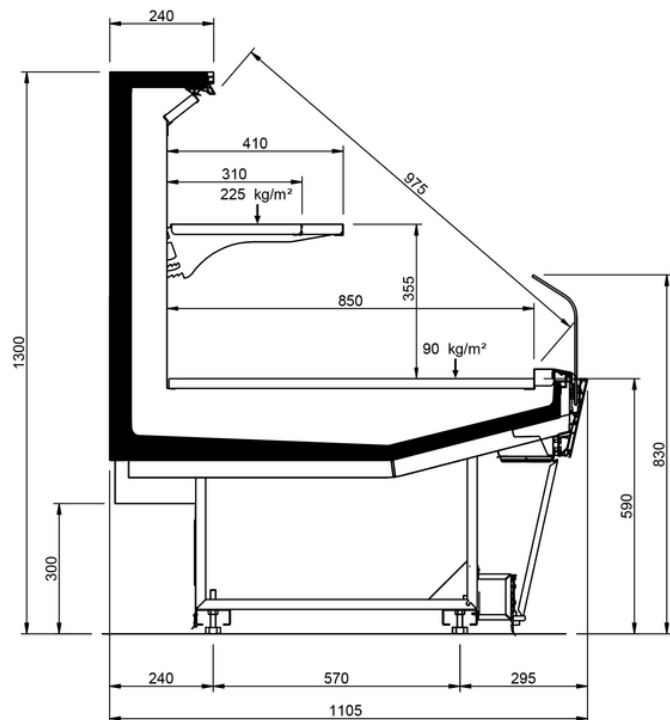



1300 LS-D STYLE

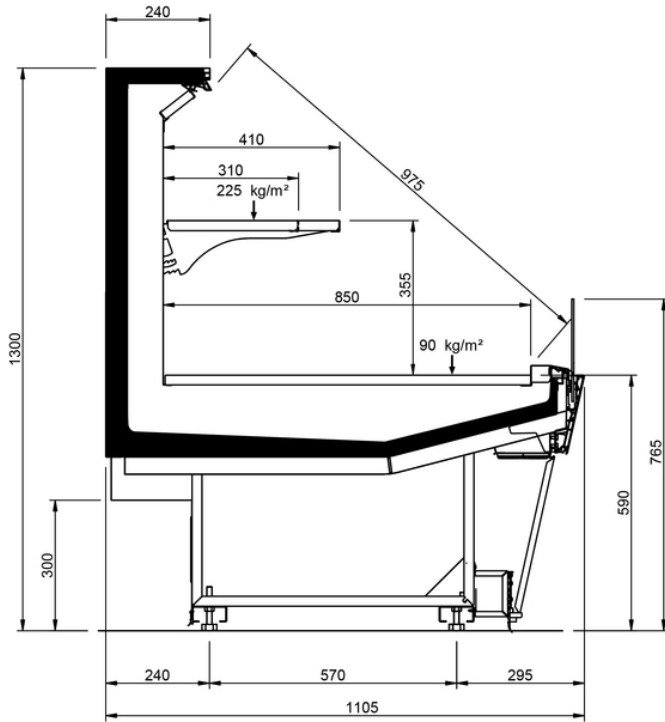

1500 LS-P W450 STYLE

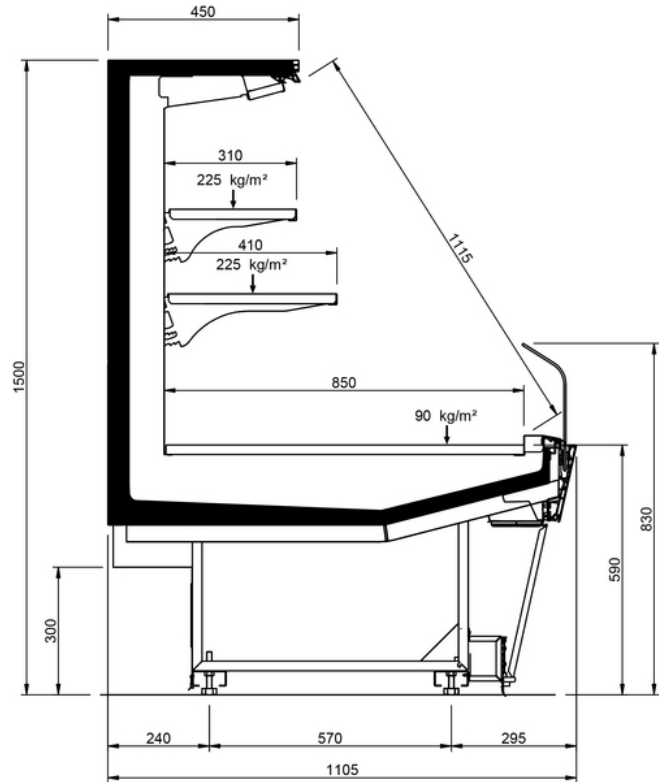

1500 LS-D W450 STYLE

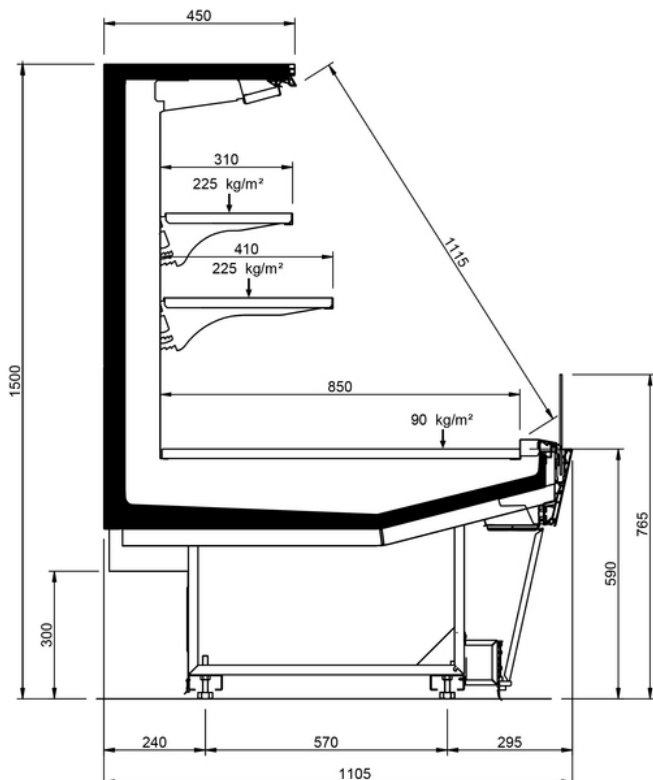

1500 LS-P W240 STYLE

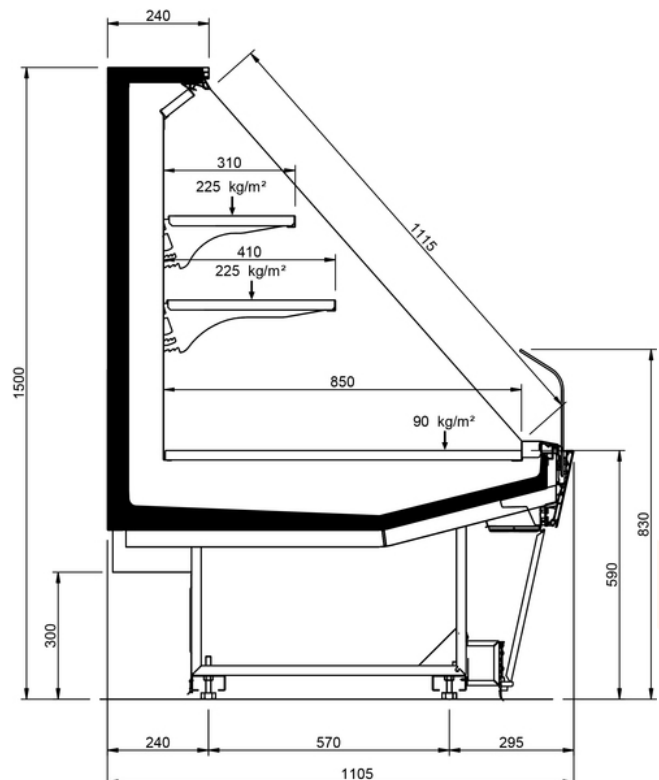

1500 LS-D W240 STYLE

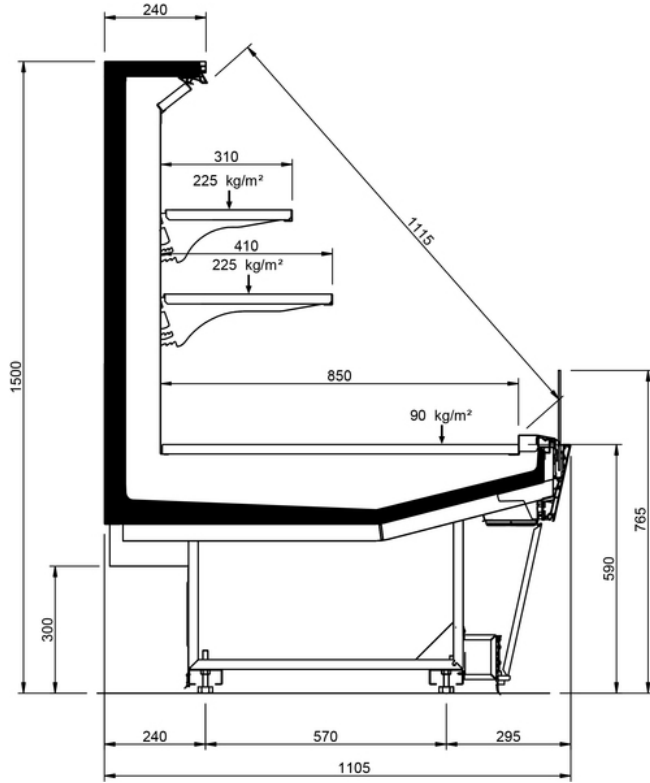

1300 LS-P STYLE FEET

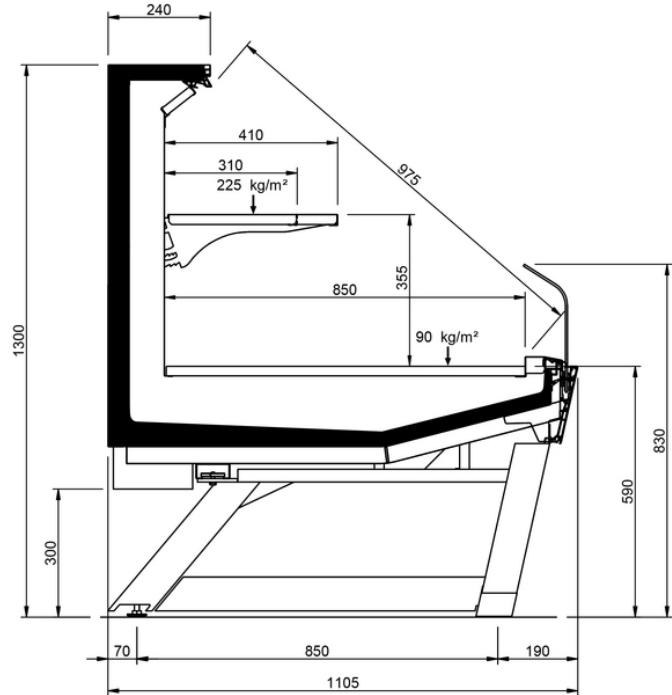

1300 LS-D STYLE FEET

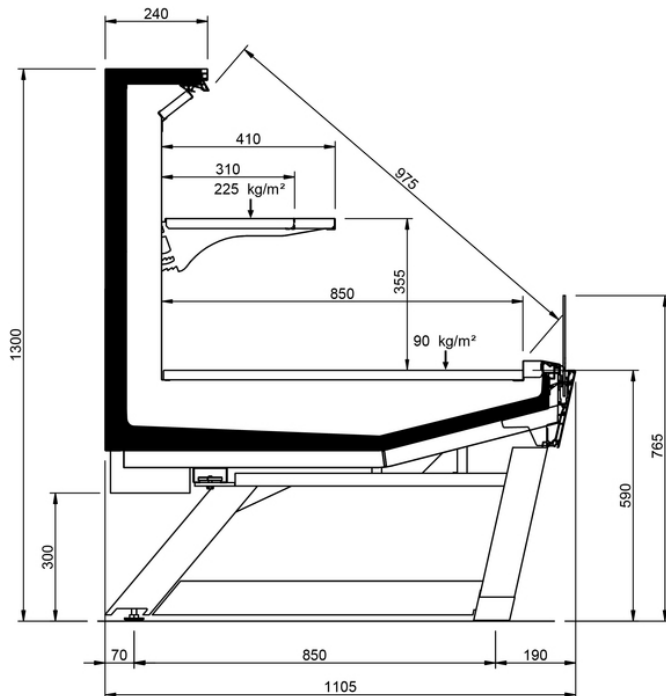

1500 LS-P W450 STYLE FEET

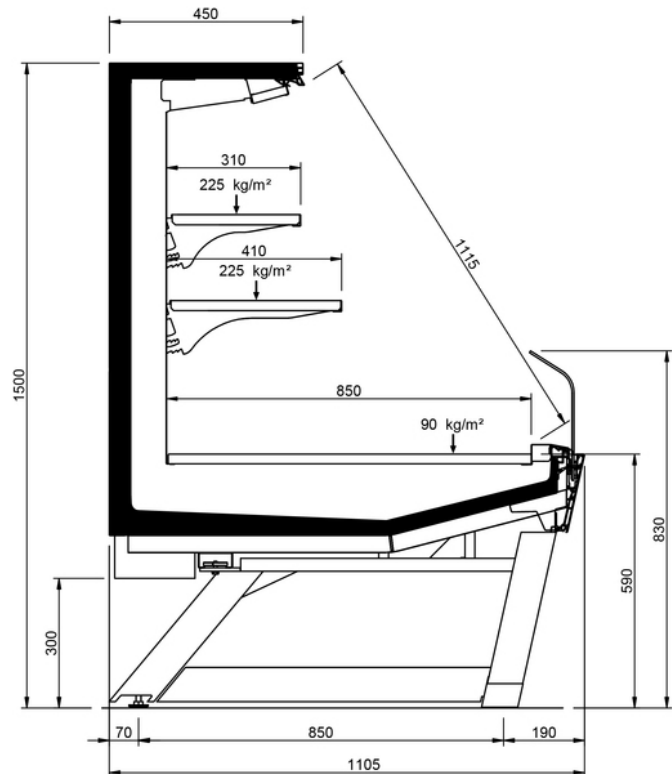

1500 LS-D W450 STYLE FEET

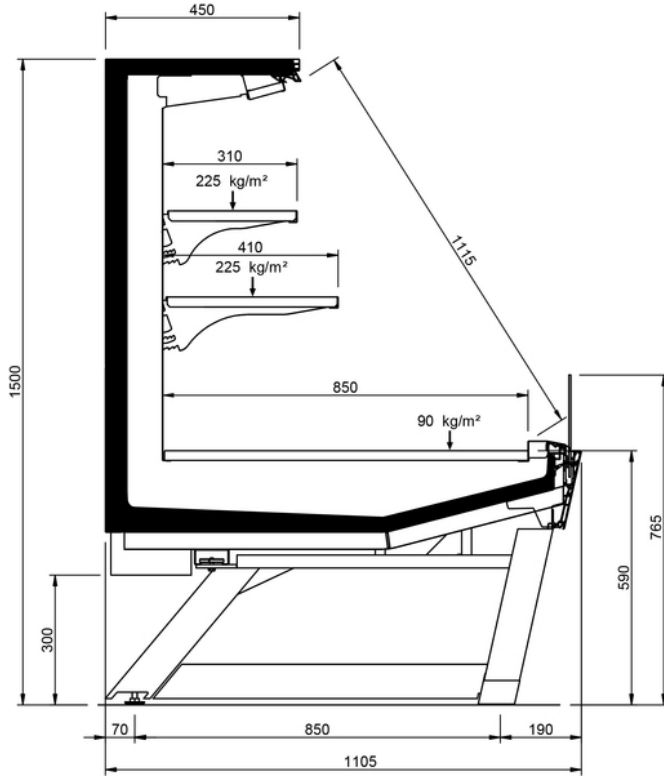

1500 LS-P W240 STYLE FEET

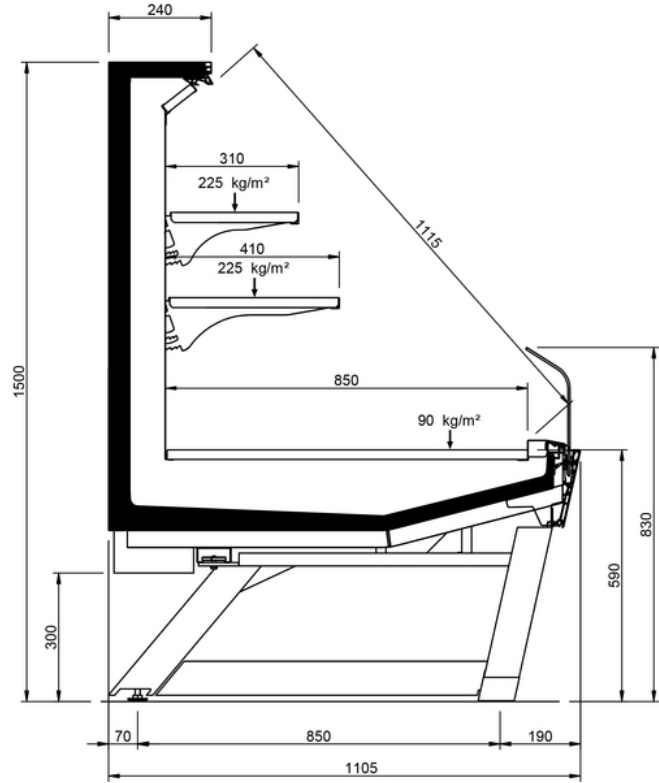



## Legenda

 Carne	 Polli	 Pesce	 Pesce confezionato
 Salumi	 Formaggio	 Latticini	 Gastronomia
 Pasticceria	 IV Gamma	 Frutta e Verdura	 Sandwiches
 Bevande	 Pizza	 Pane	 Surgelati e gelati
 Sbrinamento a fermata semplice	 Sbrinamento elettrico	 Sbrinamento a gas caldo	 Sbrinamento manuale
 Ventilato	 Statico	 Gruppo incorporato	 Gruppo remoto
 Bagnomaria	 Piano in vetroceramica	 Ghiaccio	 VSD Tecnologia con Inverter
 Illuminazione Led	 Porte Zero C	 Ventilatori ad alta efficienza	 R290 Gas refrigerante R290/Propano
 R134a R-134a - 400V/3PH/50Hz	 R404A R404A - 400V/3PH/50HZ	 R744 R744 - 400V/PH/50Hz	 Compressore semiermetico alternativo
 Compressore ermetico scroll	 Compressore ermetico alternativo	 Installazione all'esterno	 Installazione all'interno
 Insonorizzazione	 Condensatore a bordo	 Condensatore remoto	 DUAL Media e bassa temperatura